

OPERATING MANUAL



TABLE OF CONTENT

The Valve parameters and dimensions.....	2
Main Functions and Key Features	3
Outline Size Dimension.....	4~5
Technical Parameters of Electric Actuator.....	6~7
Wiring Diagram.....	8~9
Operation.....	10
Installation.....	11~12
Commissioning.....	13
Commissioning of Regulation Type Actuator.....	14~15
Troubleshooting	16
Operation Flow Chart	17

Introduction

Fluorine lined butterfly valve is in the conventional butterfly valve and valve plate lined with teflon, so that the media and valve body isolation, antiseptic effect. The valve has more and more close closure function, sealing performance is reliable. Applicable to any concentration of acid, alkali, salt and oxidative extrusion, reducing agent, organic solvents and other media.

Electric Actuator

ON/OFF Type	Feedback: the Active Contact Signal, Passive Contact Signal, Resistance, 4-20mA
Regulation Type	Input & Output Signal: DC 4-20mA, DC 0-10V, DC 1-5V
Field Operation	The Field, Remote Control Switch Regulation and MODBUS, PROFIBUS Field Bus
Voltage Optional	AC110-240V 380V 50/60Hz; DC12V, DC24V, Special Voltage Can be Customized
Protection Class	Ip65; Explosion Proof Construction Are Aailable: EX d II BT4



Technical Parameters

Body		Valve components	
Size Range	DN50-DN600	Seating Material	PTFE
Body material	Stainless Steel	Disc Material	Stainless Steel
End Connection	Wafer Flange	Stem Material	Stainless Steel
Operating Pressure	<1.6MPa	Applicable media	Control of Water, Air, Gas, Oil, Liquid, Steam
Structure	Midline Structure / A-type		

UNIT: mm

Qutine Size drawing

MEDLE	DN50	DN65	DN80	DN100	DN125	DN150	DN200	DN250	DN300	DN350	DN400	DN500
Inch	2"	2-1/2"	3"	4"	5"	6"	8"	10"	12"	14"	16"	20"
D	50	65	80	100	125	150	200	250	300	350	400	500
D1	96	104	127	153	180	206	270	320	368	428	482	605
D2	125	145	160	180	210	240	295	355	410	470	525	585
L	43	46	46	52	56	56	60	68	78	78	102	127
L1	108	112	114	127	140	140	152	165	178	190	216	229
H	212	230	233	270	298	337	407	480	555	610	715	870
n-φd	4-φ18	4-φ18	8-φ18	8-φ18	8-φ18	8-φ23	8-φ23	12-φ23	12-φ23	16-φ23	16-φ25	20-φ25
Actuator	COVNA-05	COVNA-05	COVNA-05	COVNA-10	COVNA-10	COVNA-16	COVNA-30	COVNA-30	COVNA-60			

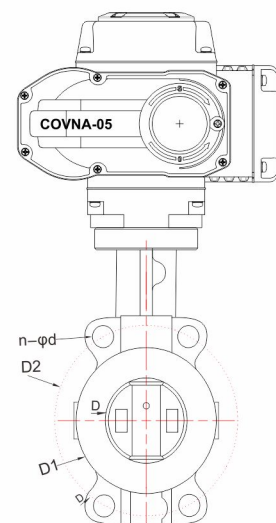
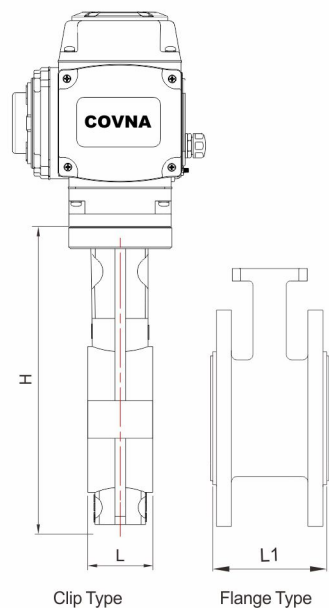

Installation Instruction

1. When removing the valve from storage, a careful check should be made to ensure that the valve has not been damaged during the storage period.
2. Valve open or close position is indicated on the notch plate for lever operated valves or on the top of the gear operator for gear operator operated valves.
3. Center valve, span body with bolts, but do not tighten. Slowly open disc to ensure that it clears adjacent pipe ID and leave at full open position.
4. For flange welding center valve with disc 10 open between flanges, span bolts, align this assembly in pipe and tack weld flanges to pipe. After tack welding, remove valve and finish welding.
5. Valve should be checked for identification purpose and ensure that characteristics of valve matches to those specified for piping specifications, for the line where that is to be mounted. Nameplate instructions will give the necessary information.

Main Functions and Key Features

1. Body: body material is hard aluminum alloy, which is treated by hard anodic oxidation and coated by Polyester powder, so that it has great corrosion resistance and protection class is IP67.
2. Motor: fully enclosed cage type motor is small in size and inertia, large in torque. Insulation class is F grade which can prevent motor over-heating;
3. Manual Override: small handle is reliable, energy-saving. It can be used for manual operation when electricity is off; In automatic operation, it can be fixed inside the clip for easy operation;
4. Indicator: indicator is assembled on center axis, valve position can be observed; Outside mirror design facilitates position observation and prevents water drops accumulation;
5. Enclosure: high sealing performance, standard protection class is IP67;
6. Limit Switches: mechanical and electronic position limit switches. Mechanical stop screw can be adjustable; Electronic limit switches can be controlled by cam. Position can be set easily and accurately by simply adjusting the cam without any influence by handle;
7. Self Lock: accurate turbo-worm structure can output large torque with high efficiency and little noise (Max. 50 decibel). Service life is quite long. Its self lock function can stop reverse rotation. Drive part is stable and reliable without additional lubrication;
8. Captive Bolt: bolts won't fall off when cover is disassembled;
9. Application: bottom connection complies with ISO5211/DIN3337 Standard. Star square hole is easy for square valve stem linear or 45° rotation application; Both vertical and horizontal assemble are available;
10. Diagram: control diagram complies with single phase or three phase wiring standard, reasonable wiring diagram and connection terminal can meet requirement of other optional functions.



Manual Override



ON/OFF Type



Regulation Type



Intelligent Type

COVNA-05

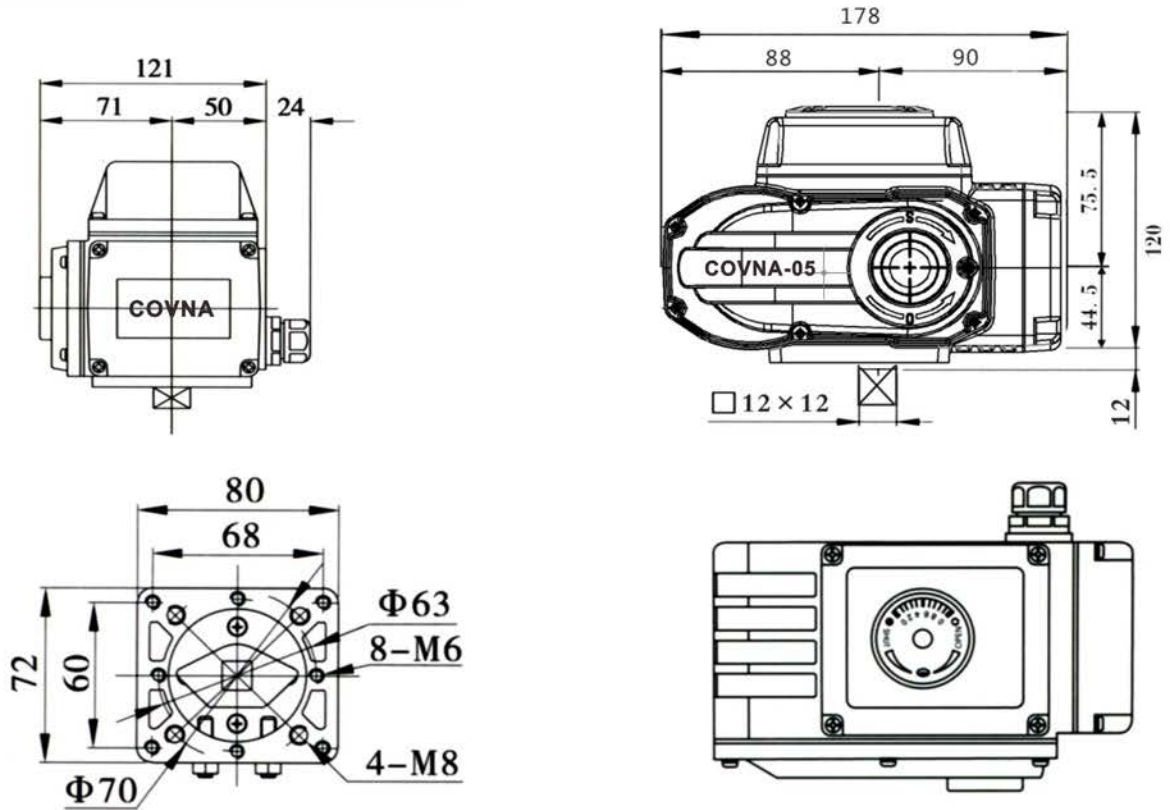

COVNA-10/16

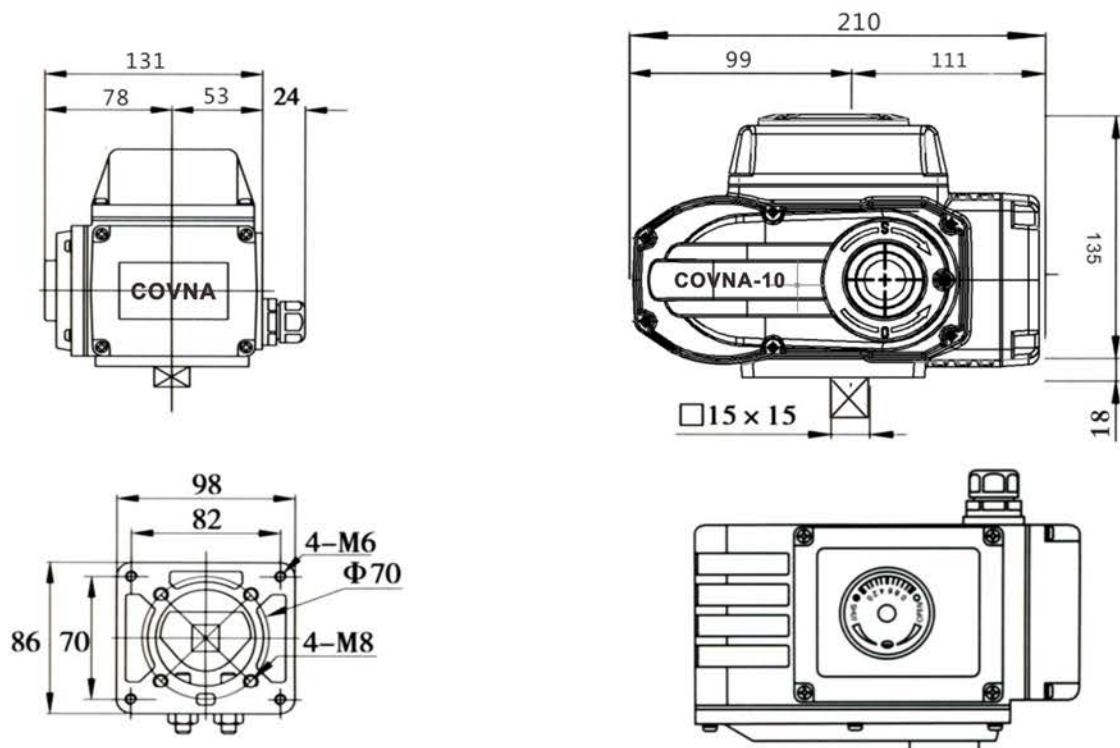

COVNA-30/60

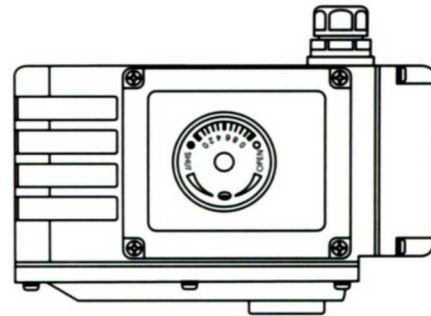
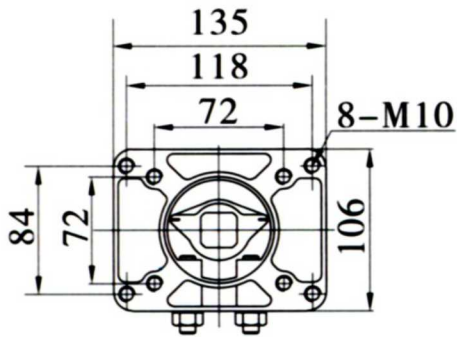
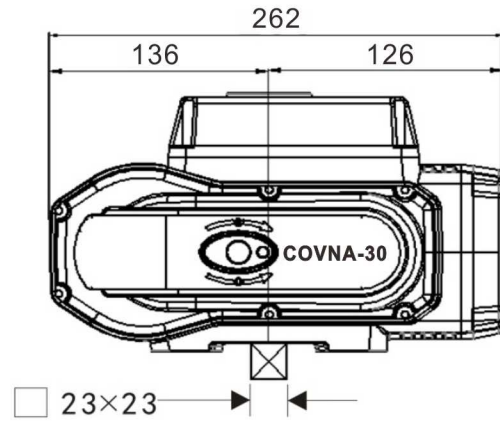
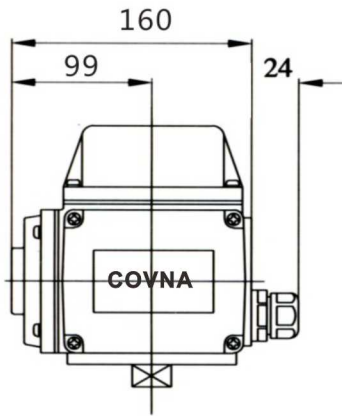

COVNA-125/250/400

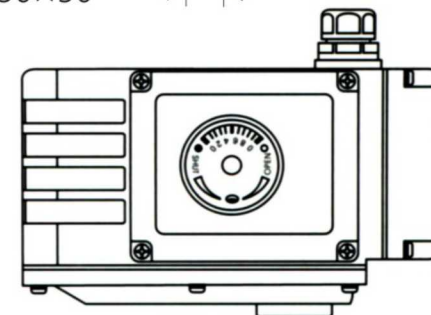
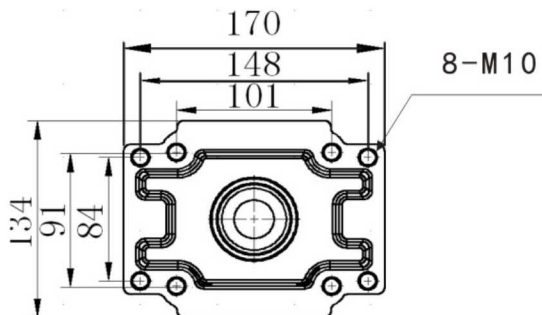
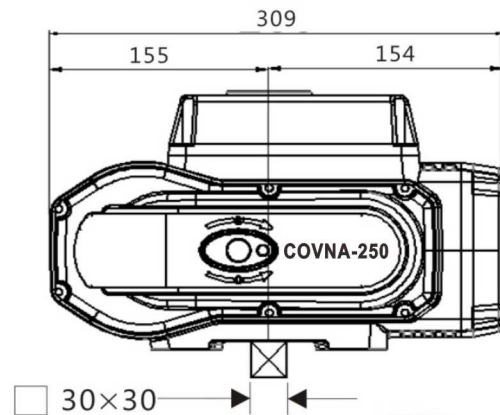
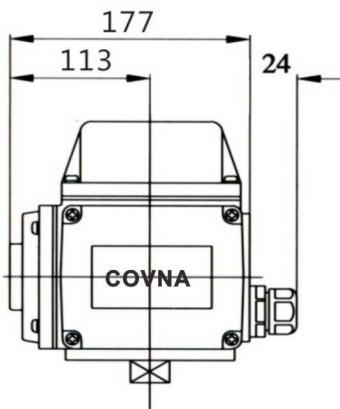

Performance Characteristics Of Electric Actuator

Model		05	10	16	30	60	125	250	400	
Performance										
Angle of Rotation		0~90°	0~90°	0~90°	0~90°	0~90°	0~90°	0~90°	0~90°	
AC220V AC Voltage	Torque Output	50Nm	100Nm	160Nm	300Nm	600Nm	1250Nm	2500Nm	4000Nm	
	90° Cycle Time	10S/ 20S/60S	15S/30S/60S			30S/60S	90S	90S	90S	
	Working Current	0.23A	0.35A	0.40A	0.45A	0.60A	1.03A	1.85A	2.7A	
	Drive Motor	50W	75W	80W	100W	130W	210W	285W	360W	
	Voltage Options	AC220V, AC110V, AC24V								
	Control Circuit	B: ON/OFF Type with Passive Contact Signal Feedback								
DC DC Voltage	Torque Output	60Nm	110Nm	170Nm	330Nm	680Nm	1300Nm	2500Nm		
	90° Cycle Time	8S	11S	11S	9S	35S	32S	32S		
	Starting Current	0.74A	1.40A	1.40A	3.80A	7.0A	3.8A	4.3A		
	Working Current	0.38A	0.38A	0.40A	1.03A	0.70A	1.2A	1.4A		
	Drive Motor	9.5W	9.0W	9.6W	30W	33W	30W	33W		
	Voltage Options	DC12V, DC24V, DC110V, DC220V								
Control Circuit	F: DC24V/ DC12V Direct ON/OFF Type									
AC380V	Torque Output	70Nm	100Nm	200Nm	300Nm	600Nm	1300Nm	2500Nm		
	90° Cycle Time	20S	27S	27S	25S	26S	50S	50S		
	Starting Current	0.20A	0.28A	0.30A	0.55A	0.45A	0.60A	0.77A		
	Working Current	0.16A	0.25A	0.27A	0.53A	0.43A	0.65A	0.75A		
	Drive Motor	51W	70W	77W	117W	220W	90W	103W		
	Voltage Options	AC380V								
Control Circuit	G: AC380V Three-Phase Power Supply with Passive Signal Feedback (Default) H: AC380V Three-Phase Power Supply with Resistance Potentiometer Signal Feedback (Optional)									
Protection Class		IP65								
Ambient Temp.		-30°C~+60°C								
Installation Angle		Any								
Electrical Connection		G1/2 Water-proof Cable Connectors, Electric Power Wire, Signal Wire								

Note: Can't connect one actuator parallel with other ones, in other words, can't use the same control -ler contact points to control two and above actuators, otherwise it will cost out of control, motor overheating, product damage and shorter service life.

ON/OFF Type Performance characteristics

COVNA HK Series the on-off actuator has only two actions (0° or 90°) when performing valve operations, which means that the valve can only be fully open or fully closed. Can not control the amplitude of the valve switch, and can not control the medium flow. The on-off valve is generally used to switch off the two positions. There are two positions of full open and full closed. The function is to open or close to conduct and cut off the working medium inside. There is no special requirement for the flow characteristics, but for the switching speed, The leakage requirement is higher than that of the regulating valve.

Voltage Options	AC110V, AC220V, AC380V, DC24V, AC24V
Insulation Resistance	100MΩ/500V
Withstand Voltage	1500V; 1 min
Control Circuit	A: ON/OFF Type with Light Indicator Signal Feedback B: ON/OFF Type with Passive Contact Signal Feedback C: ON/OFF Type with Resistance Potentiometer Signal Feedback D: ON/OFF Type with Resistance Potentiometer and Neutral Position Signal Feedback E: Regulation Type with Servo Control Module F: DC24V/ DC12V Direct ON/OFF Type G: AC380V Three-Phase Power Supply with Passive Signal Feedback H: AC380V Three-Phase Power Supply with Resistance Potentiometer Signal Feedback
Optional Function	Over Torque Protectors, Dehumidify Heater, Stainless Steel Coupling & Yoke

Regulation type Performance characteristics

COVNA HK Series the regulation type electric actuator has the function of a switch type integrated structure, and relatively increase the intelligent control module, so as to accurately control the valve (any angle between 0°-90°), adjust the medium flow, and control by input or output The signal 4-20mA or 0-10v/1-5v can control the opening of the valve; the performance reflects the control accuracy, the control accuracy is generally within 1% of the error, and the opening and flow can be adjusted very accurately.

Voltage Options	AC110V, AC220V, AC380V, DC24V, AC24V
Input Signal	4-20mADC 1-5VDC 0-10VDC
Output Signal	4-20mADC 1-5VDC 0-10VDC
Tolerance	±0.5%
Return Difference	<0.3%
Dead Zone	0.1% to 1.6%
Damping Characteristics	0
Mechanical Repeatability Error	0%

Note: Can't connect one actuator parallel with other ones, in other words, can't use the same control -ler contact points to control two and above actuators, otherwise it will cost out of control, motor overheating, product damage and shorter service life.

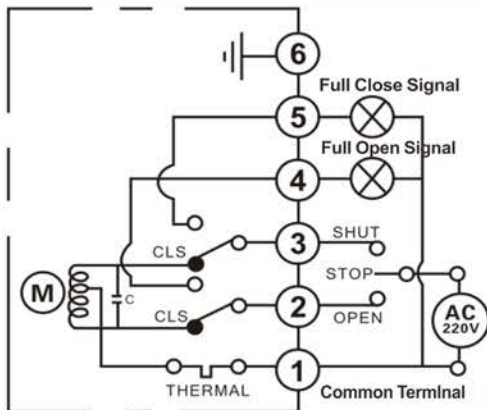

A: ON/OFF Type with Light Indicator Signal Feedback

Function: Finish open or close operations by the circuit, and the actuator outputs a signal of active position (full opening, full closing)

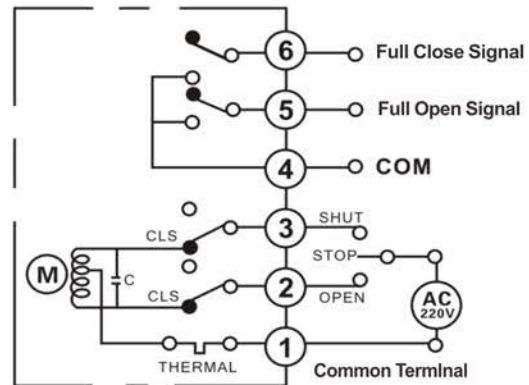

B: ON/OFF Type with Passive Contact Signal Feedback

Function: Finish open or close operations by the circuit, and the actuator outputs a set signal of passive position (full opening, full closing)

Structure: with two neutral positions switches

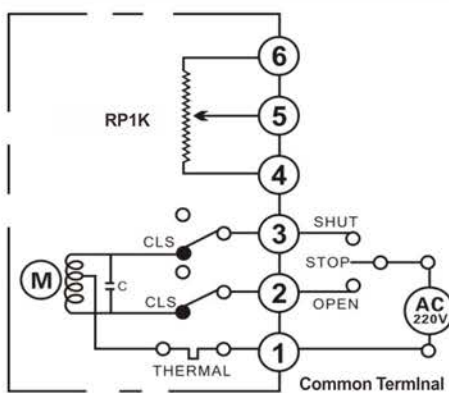

C: ON/OFF Type with Resistance Potentiometer Signal Feedback

Function: Control the open angle of valves by circuit, and the actuator outputs the resistance signal corresponding to the position of switch

Structure: with 500Ω or 1000Ω potentiometer

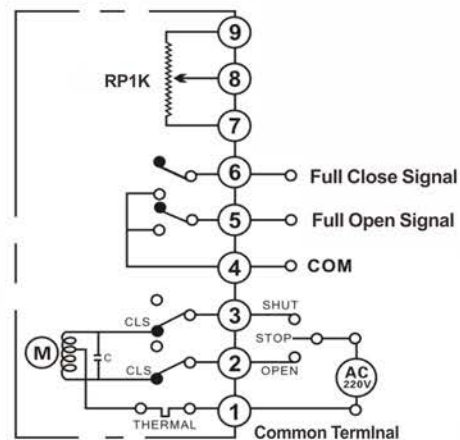

D: ON/OFF Type with Resistance Potentiometer and Neutral Position Signal Feedback

Function: control the open angle of valves by circuit, and the actuator outputs the resistance signal corresponding to the position of open position, at the same time, outputting a set signal of passive position

Structure: both potentiometer style and neutral positions switch style

Caution:

Can't connect one actuator parallel with other ones, in other words, can't use the same controller contact points to control two and above actuators, otherwise it will cost out of control, motor overheating, product damage and shorter service life.

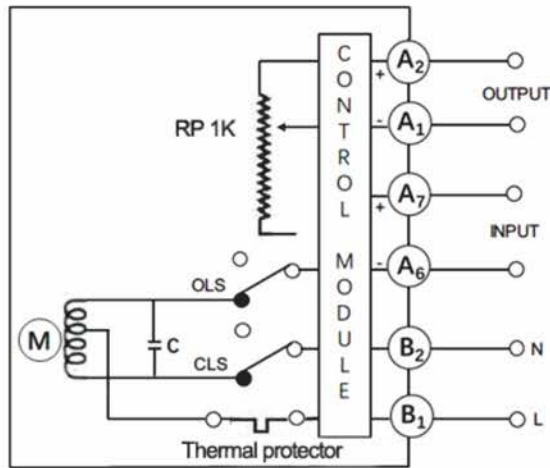

E: Regulation Type with Servo Control Module

Function: Modulating, input & output
DC4-20mA, 1-5VDC, 0-10VDC

Structure: With servo control module and
1000Ω potentiometer

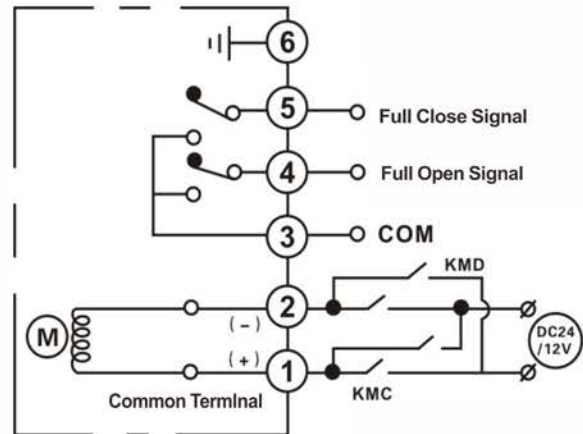

F: DC24V/ DC12V Direct ON-OFF Type

Function: The external circuit make positive and negative conversion of DC power to open or close, and the actuator outputs a set signal of passive position (full opening, full closing),

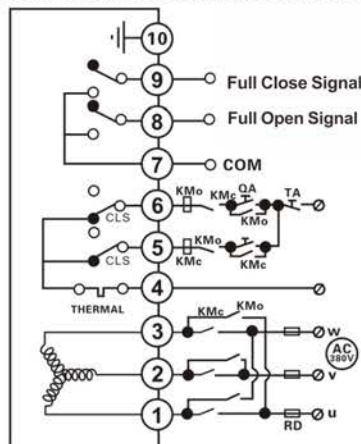

G: AC380V Three-Phase Power Supply with Passive Signal Feedback

Function: The external circuit make positive and negative conversion of DC power to open or close, and the actuator outputs a set signal of passive position (full opening, full closing)

Notes:

Please kindly note if the switch position is correct when the three phase electric actuator is being adjusted, if it's opposite direction, then make 2 of power lines exchange each other

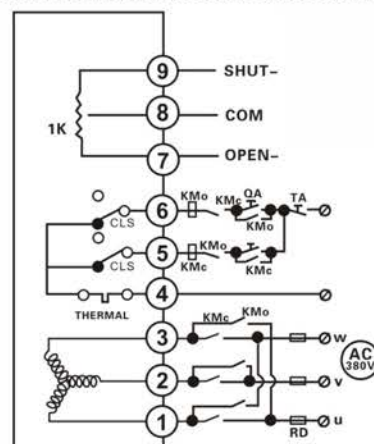

H: AC380V Three-Phase Power Supply with Resistance Potentiometer Signal Feedback

Function: The external circuit make positive and negative conversion of DC power to open or close, and the actuator outputs a set signal of passive position (full opening, full closing)

Notes:

Please kindly note if the switch position is correct when the three phase electric actuator is being adjusted, if it's opposite direction, then make 2 of power lines exchange each other

Caution:

Can't connect one actuator parallel with other ones, in other words, can't use the same controller contact points to control two and above actuators, otherwise it will cost out of control, motor overheating, product damage and shorter service life.

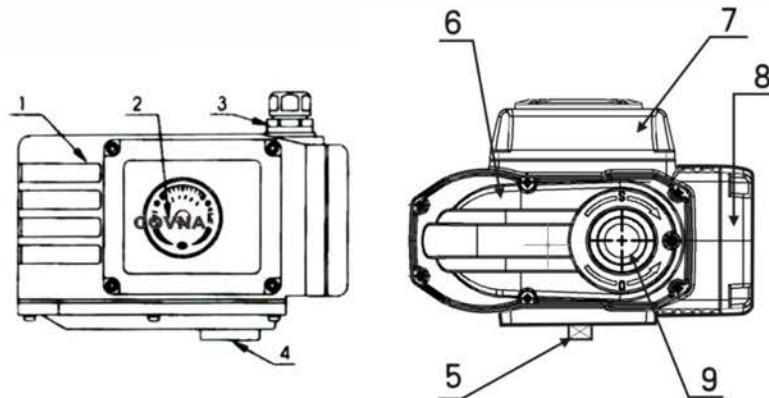

Construction					
1	Shell	4	Rubber Cap	7	Electric Cover
2	Position Indicator	5	Output Shaft	8	Terminal Box
3	Inlet Wire Lock	6	Gear Box Cover	9	Manual Override

The actuator are fully debugged before they go out, if they don't meet your demands because of the valve body, the coupling in actual installation. Please resume debugging according to following steps:

● **Assembly the actuator to the valve (refer to *Installation*)**

● **Discharge the electric cover of actuator and debug as following steps according to the actual state of valve:**

- ① Adjustment of limit position switch (refer to **Commissioning**);
- ② Adjustment of neural position switch (refer to **Commissioning**);
- ③ Adjustment of regulation type actuator (only for E style, refer to **Commissioning of regulation type actuator**);
- ④ Adjustment of mechanical limited location block (refer to **Commissioning**).

● **The manual test run**

- ① Take off the rubber cap of manual handle hole; inset the hand shank into hole and rotate it clockwise decreased valve opening.
- ② Check whether the limit switch is running or not when the valve is full closing position (sensitive switch making crack sound when it is running), then turn the adjusting screw a half turn to check if the screw could touch the mechanical limited location block.
- ③ Turn hand shank anticlockwise to increase valve opening, check the situation of limit switch and mechanical limit location block the same method, make trial turn to see whether they are all right.

● **The electric test run**

- ① Take off terminal box, wiring correctly according to wiring diagram
- ② Separately turn on the power on clockwise and anticlockwise and see whether the actuator and the valve are working correctly. (The direction of shut point (clockwise) show close, the direction of open point (anticlockwise) show open.

1. Installation environment

- The product can be installed indoor and outdoor.
- product is non-explosion-proof production, and the installation must be avoided being in flammable or explosive environment etc.
- The actuator should be in protection box in the environment of long-term with the splash of rain, material and direct sunlight.
- Please reserve space for controller, manual operation.

★ The surrounding environment temperature should be in -30°C~+60°C

2. Temperature of working medium

- When matching with the valve, the actuator body's temperature will a bit rise if medium temperature happen heat transfer.
- If the temperature of medium is high, the bracket has the function of reducing heat conduction.
- Please select the standard bracket if temperature of working medium below 60°C.
- Please select the standard bracket when temperature of working medium above 60°C.

3. Installed on the valve body (Figure 3)

- Manually operate the actuator to drive the valve, confirm it does not have abnormal situation. Turn the valve in full closed position.
- Assemble the bracket to the valve body.
- Set one end of couplings on valve spindle.
- Turn the electric actuator to full closing position, and insert output-input shaft into the square holes of couplings.
- Set the screw between the electric actuator and bracket.
- Turn actuator by hand shank, confirm that it moves translation, no eccentric, no skew and no overrun.

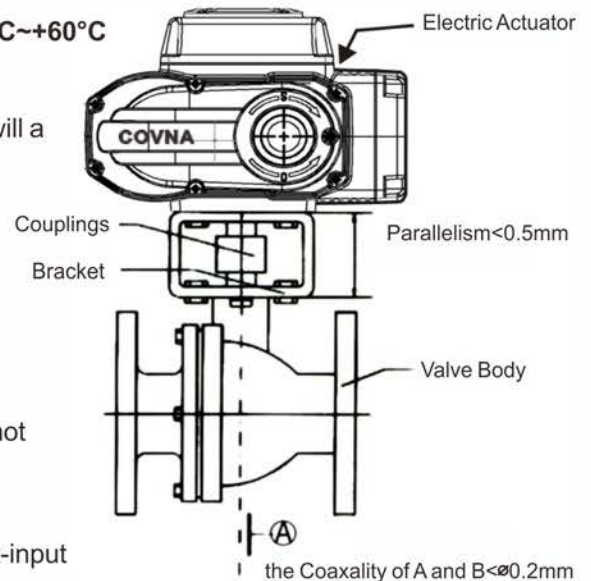

Figure 3

4. Cable installation

- Install wire tubes as shown in Figure 4.
- The outside diameter of wire tubes should be $\varnothing 9\text{-}\varnothing 11$.
- Take measures to proof water.
- To prevent actuator from flowing into wire tubes water, the actuation position should higher than wire tubes position.
- When installing wire, the outside diameter of wire should be $\varnothing 9\text{-}\varnothing 11$.
- As figure 5, in case the water flow into actuator interior from line locking, all wire that are not allowed to be used.
- The signal wire should be shielded wire in principle, don't parallel it to power wire.

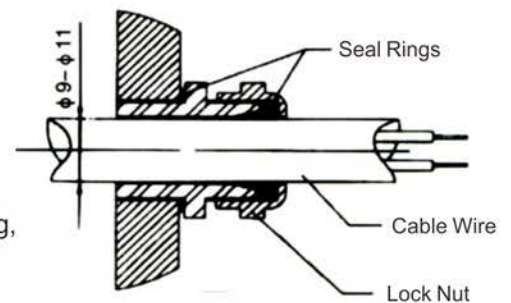

Figure 4

5. Special tips

- Caution: can't connect one actuator parallel with one another, in other words, can't use the same controller contact point to control more than one actuator, otherwise it will cause out of control, motor overheating, product damage, shorter service life.
- If the actuator is installed outdoor, we suggest equipping other protective cover to proof water, stabilize mechanical property, make a longer service life.

6. Power voltage: 220VAC 50Hz/60Hz

7. Guard line options for witch of cutting-off winding

Item	Guard Line	Motor Power W/F
05	3A	10
10/16	5A	25, 30
30/60	7A	40, 90
125/250/400	10A	100, 120, 140

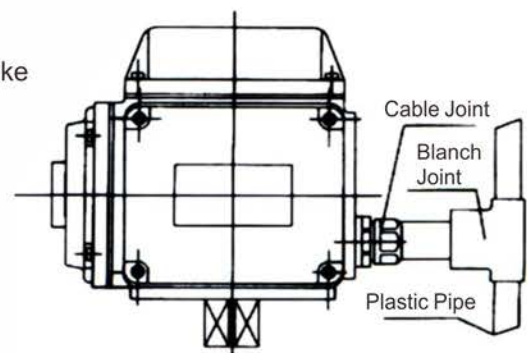
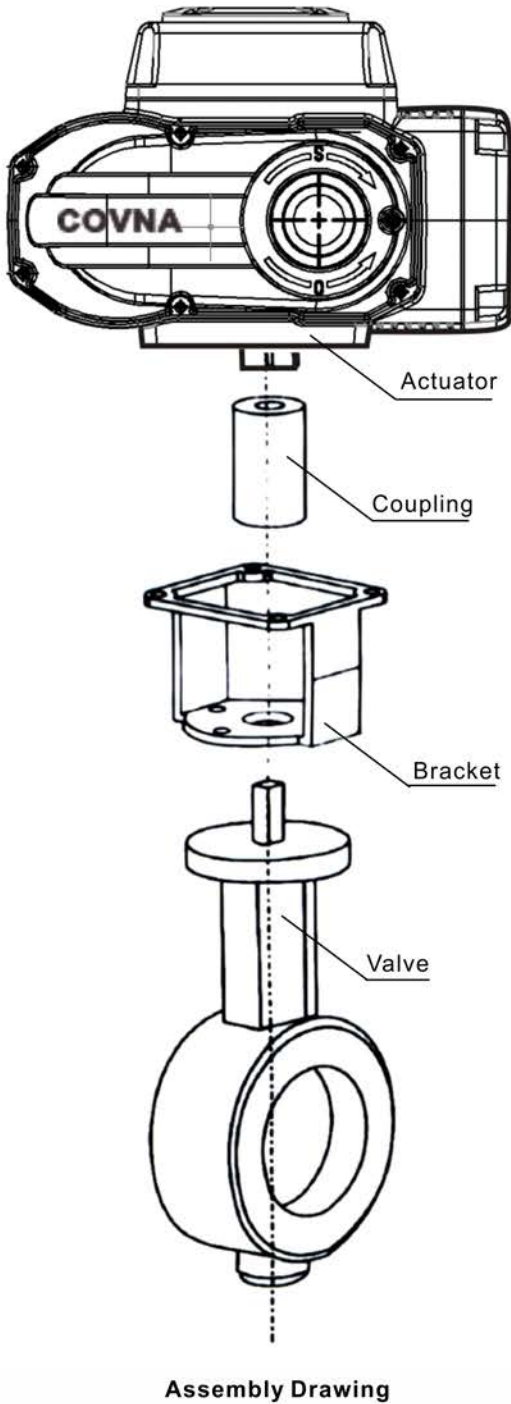
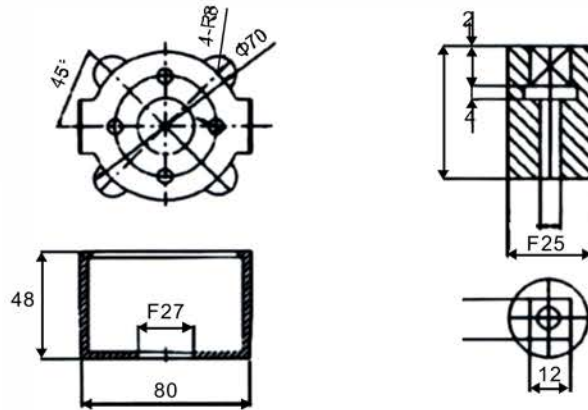

Figure 5



● Z type bracket and couplings (match with 05)



● S type bracket and couplings (match with 10/16)

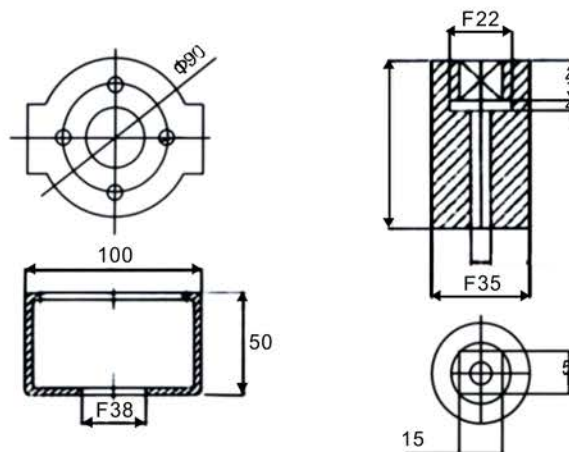

● M type bracket and couplings (match with 10/16)

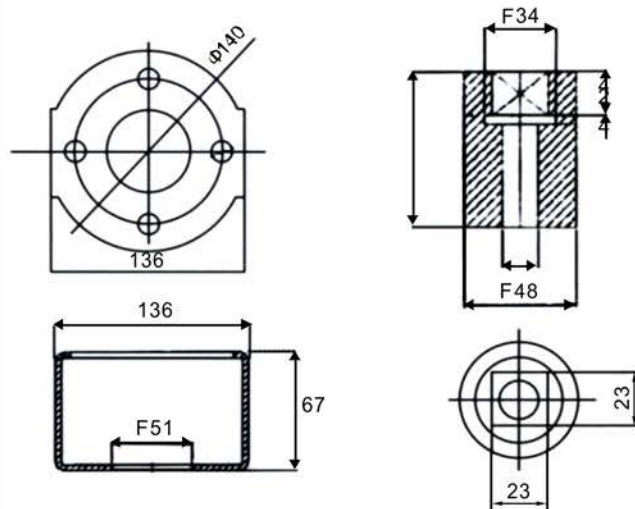

1. Adjustment of limit position switch (Figure 6)

- Turn the valve to full opening position by hand.
- Loosen the screw of travel block and turn the block to drive the travel switch, then fine-tuning sensitive switch until hearing "click", after that, set screw.
- The way of adjustment full opening position is the same as above.

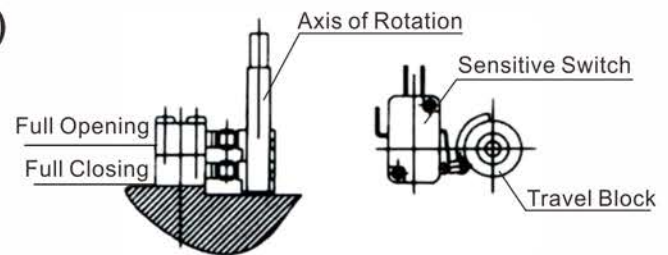

(Figure 6)

2. Adjustment of middle position switch (Figure 7)

- Use hand shank to drive the valve to the position it need.
- Loosen the screw of travel block and turn the travel block to drive sensitive switch, then set screw.
- These two neutral position switches' position could be adjusted according to need.

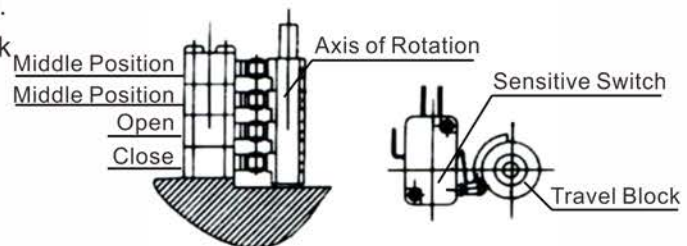

(Figure 7)

3. Adjustment of potentiometer (Figure 8)

- Use hand shank to drive actuator to neutral position, and turn the pointer point to 50% scale line.
- Use multimeter to test resistance of first and third port of potentiometer (resistance between the first port and third port in potentiometer), and mark R (potentiometer default is $1K\Omega \pm 15\%$ if no special request).
- Separate potentiometer gear from the opening gear by suitable external force on potentiometer fixing plate.
- Put one probe of multimeter to one potentiometer terminal, the other probe to another terminal, then rotate potentiometer gear and see number in multimeter. When the resistance value is equivalent to $R/2 \pm 2\Omega$, stop rotating, after that, mesh these two gears.

4. Adjustment of mechanical limit location block (Figure 9)

- Use hand shank to drive valve to full opening position and operate the switch (sensitive switch makes crack sound when it is running).
- Loosen the nut and turn the adjusting screw to touch the mechanical limit location block, then turn the adjusting screw a half turn back, set nut.
- Adjusting the full opening position by the same way as above.

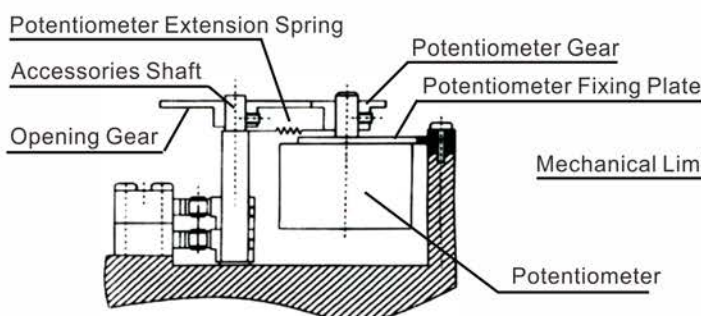

(Figure 8)

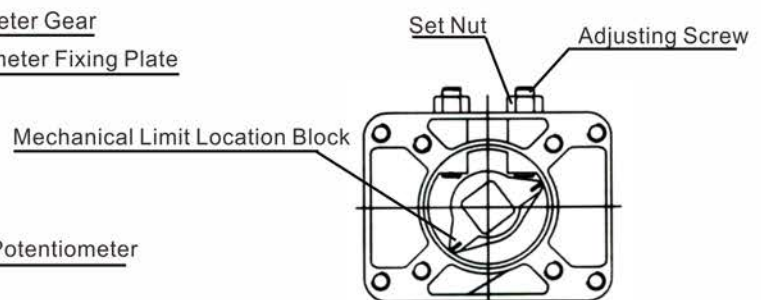

(Figure 9)

1. Function of electrical limit and mechanical limit

① Electrical stroke limit function:

When the actuator reaches at fully opened/fully closed or the middle position, the built-in electrical limit switch will cut off the circuit to protect the actuator.

② Mechanical limit function of output shaft:

When electrical stroke limit function fails, output shaft will be locked by mechanical limit to protect the valve from damage.

Figure 10 shows the position relationship between electrical limit and mechanical limit.

2. Adjustment of actuator (Figure 10)

- ① Adjust the over-travel limit stopper to zero position and full position, and ensure electrical limit position angle is 90°.
- ② Adjust mechanical position limitation base on electrical limit position angle.

3. Connection of actuator with servo control module

● Potentiometer installation and connection (Figure 11)

- ① Finish potentiometer installation and connection according to "Commission" in previous chapter.
- ② Use multimeter to check resistance of potentiometer in middle opening position, and ensure it has homogeneous continuous variable from 0-100% opening.

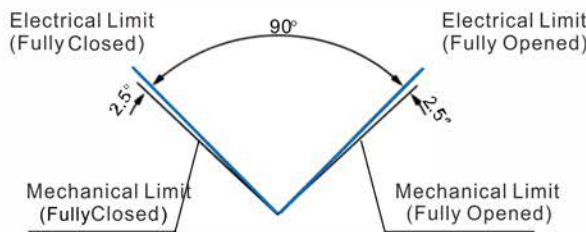

(Figure 10)

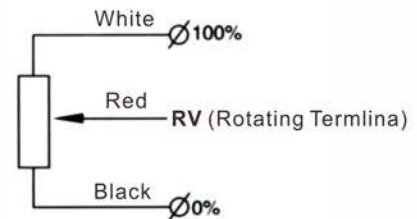

(Figure 11)

● Electrical wiring of the servo control module (Figure 12)

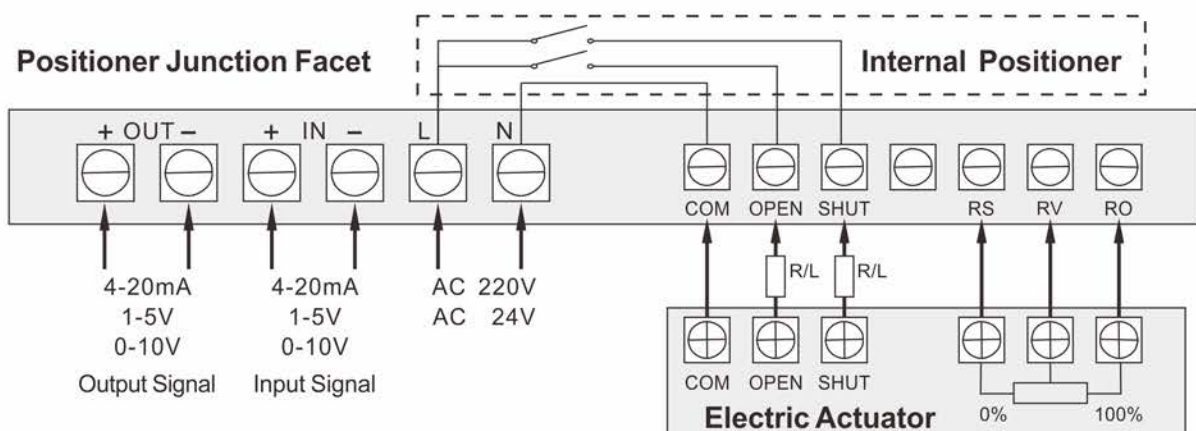

(Figure 12)

Module Operating Interface

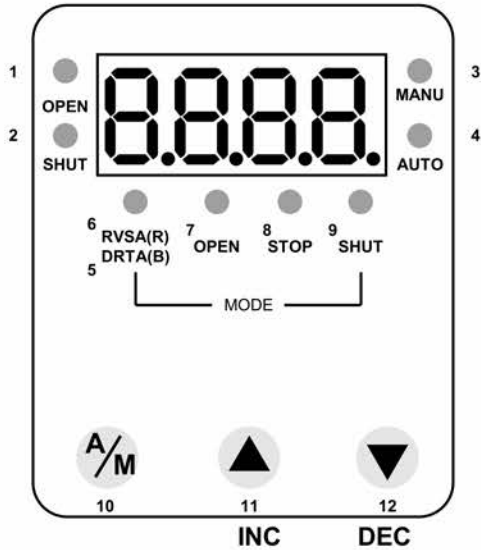

Status indication	1	OPEN	Output control "open"
	2	SHUT	Output control "shut"
	3	MANU	Manual control status
	4	AUTO	Auto control status
Mode indication	5	DRTA	Operating by clockwise, the input signal is corresponding to 4mA-full position (usually we calibrate it to be full opening), 20mA-zero position (usually we set it to be full closing)
	6	RVSA	Operating by anticlockwise, the input signal is corresponding to 4mA-full position (usually we set it to be full opening), 20mA-zero position (usually we calibrate it to be full closing)
	7	OPEN	Input opening signal to make the actuator open to maximum opening degree
	8	STOP	Input stopping signal to make the actuator stop running
	9	SHUT	Input shutting signal to make the actuator shut to minimum closing degree
Button	10	A/M	Automatic or manual mode toggle key, parameter change and toggle key
	11	▲	Values increase button, it use for switching display to original set degree of opening, when it's in automatic mode, opening action when it's maual mode
	12	▼	Values decrease button, it's use for switching display to the temperature of valve positioner shell when it's in automatic mode

4. Zero Calibration

After wiring between valve positioner and actuator like Figure 12, the rotation angle has to be calibrated in the first match between positioner and actuator, after that the positioner could work correctly, the demarcation has no effect on input and output of valve positioner.

Method one: simple automatic calibration (this method request the actuator has electric limit position stopper and mechanical limit position stopper). In the automatic mode, press both A/M and buttons at the same time, then release these two buttons at the same time, the actuator will start automatic calibration and confirm the zero position (full closing) first. The valve runs to the small angle direction and reaches at minimal opening position which is judged as zero position (valve position 0.0). After that the actuator runs to maximum opening direction and reaches at maximum opening position which is judged as full position (valve position 100.0). After judgment, the actuator returns to automatic calibration and saves results by itself.

Method two: calibrate your need (this method request button idle time less than 8 seconds in the progress of calibration). In the automatic mode, press A/M button into u0 parameter, pass u1, u2, u3, u4 and into u5, revise u5=003.1, finally press A/M button.

- ① Enter u6, press ▲ or ▼ button to make actuator to run to "open" or "shut" direction, meanwhile, the screen shows the situation of actual valve opening degree is increasing or decreasing. If the opening arrival at Zero position that it's your expected position (you can see it if actuator is already assembled valve body, and the valve is set in full closing position in general), press A/M button to confirm it, enter u7 parameter.
- ② In u7 parameter, press ▲ or ▼ to run to your expected full position in the same way, and press A/M to confirm full position (you can see it If actuator is already assembled valve body, and the valve is set in full opening position in general), then back to u5.
- ③ Revise u-00.5 and back to measurement and control status.

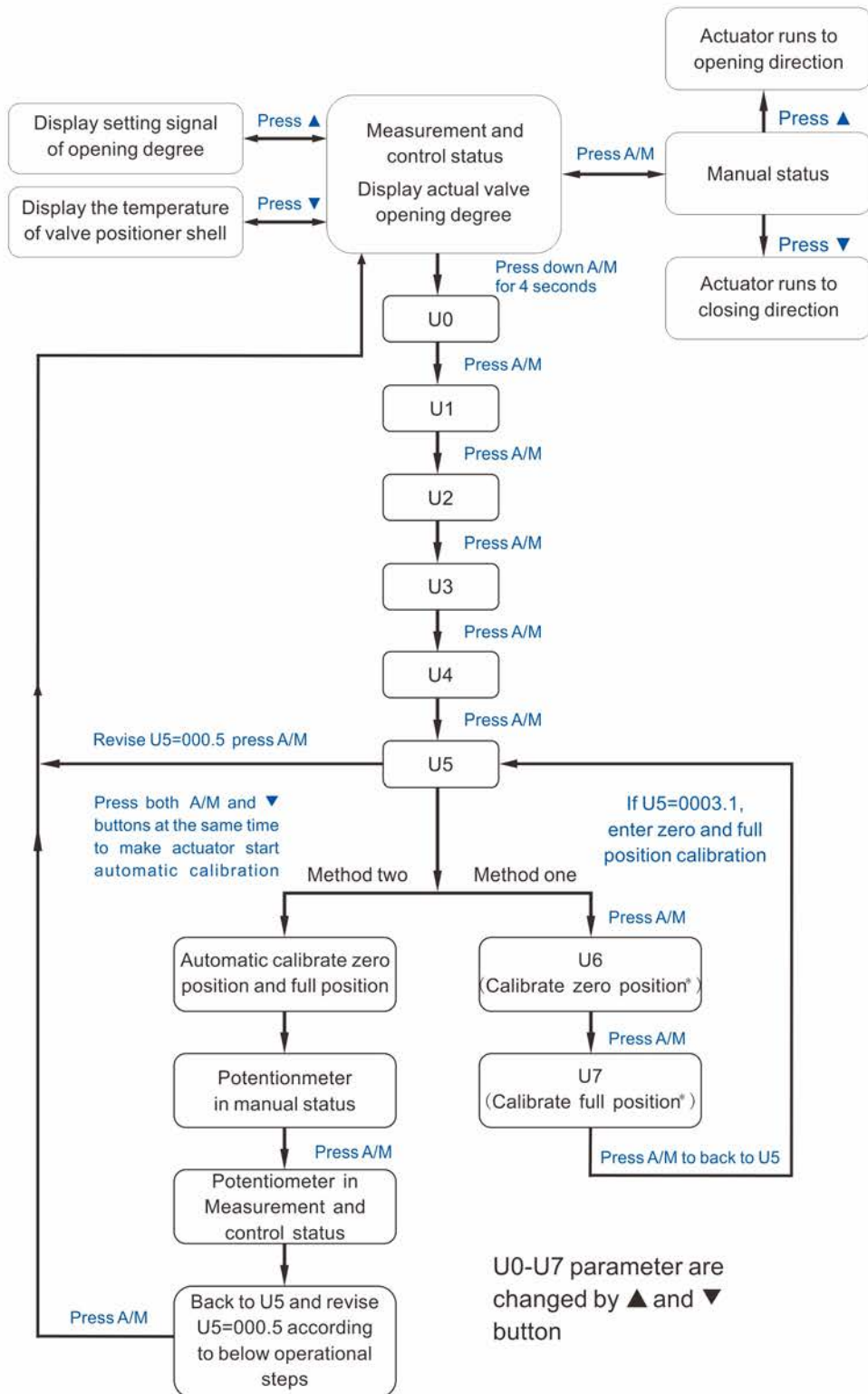

NOTE: Each parameters of regulation type actuator have already been calibrated before leaving factory. Do not alter it unless it must. If really do, please read it carefully before commissioning.

5. Error message and solution

Error Code	Meaning
E-01	For example, the signal of zero position is calibrate to be 4mA, but the given current $\leq 3.0\text{mA}$. The actuator will start signal interrupt handler and show E-01 in screen
E-03	① Signal feedback lines of valve positioner and actuator are inversely connected ② Switch lines are inversely connect
E-05	The actuator has large oscillation because of input signal or feedback signal unstable, too high precision, etc
E-06	The actuator isn't able to open direction
E-07	The actuator isn't able to run to shut direction
E-08	The Internal temperature of positioner is higher than 80°C

Maintenance

- ① No extra oil required because the molybdenum grease we put are with long service life and high with-stand voltage.
- ② Please take periodical inspection to the actuator if you don't use it frequently.

Troubleshooting

Fault phenomenon	Possible reason	Solution
Motor does not start	Lacking of power supply	Connect the actuator to power supply
	Electric wire broken, wiring terminals loose	Repair the wire, tighten wiring terminals
	Supply voltage is wrong or below level	Check the voltage is correct or wrong
	Overheat protector activated (ambient temperature is too high, the valve is stuck)	Reduce ambient temperature, manually open/close the valve to see if it is working
	Limit switch disfunction	Replace the limit switch
	Capacitance doesn't start or running	Replace the capacitance
Opening & closing Indicator light doesn't light	Indicator light is broken	Replace the indicator light
	Limit switch disfunction	Replace the limit switch
	Adjusting of block disfunction	Readjustment
Opening degree chang-ing constantly	Signal source has interference signal	Check input signal
	Voltage divider generated interference	Replace the potentiometer
	Voltage divider gear or opening gear loose	Tightening up the screws of gear

SOLENOID VALVE



ELECTRIC VALVE



PNEUMATIC VALVE



SPECIALIZED FLUID CONTROL VALVE MANUFACTURER

COVNA Headquarter:

Building C, Longchang Micro-Chuangyuan, No. 26 Hantang
Street, Dongcheng District, Dongguan City, China, 523000

E-mail: Bond@covna-china.com

Tel: 86-769-22456666 22763199

Fax: 86-769-22825120

www.covna-china.com

www.covna-valve.com



FOLLOW US